

F 2000 F 4000

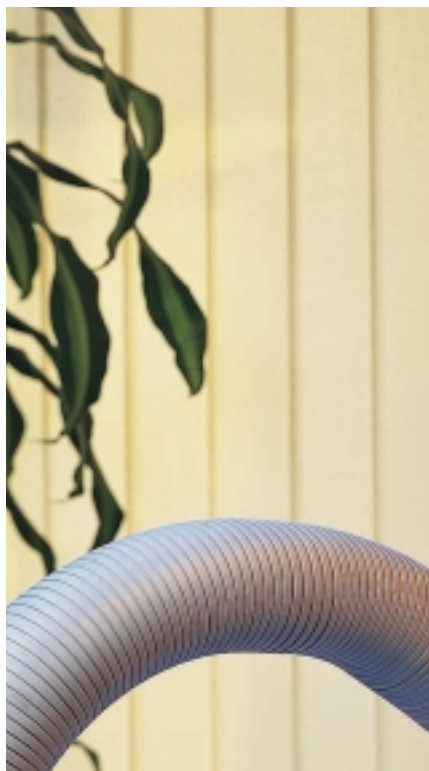

FILTRI CENTRALIZZATI
FILTRES COMPACTS



La serie “F” di filtri per l’aspirazione e la deodorazione dei fumi di saldatura a stagno, è stata concepita e realizzata consentendo una modularità nei dispositivi di filtrazione che ne estendono enormemente il campo di impiego. Progettati per l’industria elettronica per l’aspirazione e filtrazione di fumi da postazioni di lavoro fino a 12 (F 1200), saldatrici ad onda, pozzetti di saldatura stagno, trovano applicazione anche nei settori chimico-farmaceutico, industria orafa, scuole professionali.

La filtrazione avviene attraverso tre diversi stadi di lavoro ad efficienza crescente monitorati visivamente mediante pressostato differenziale, o attraverso una cartuccia filtrante riutilizzabile; in questa versione il pressostato differenziale viene fornito come optional. Nella versione con carboni attivi questi ultimi non sono rigenerabili e devono essere regolarmente cambiati.

La série des filtres pour l’aspiration et l’élimination des fumées de soudeure étain à été programmée et réalisée pour permettre aux dispositifs de filtration d’être plus flexibles et polyvalents. Cette série à été étudiée pour l’industrie électronique pour aspirer et filtrer des fumées, produites par des postes à souder, soudeuse à l’étain jusqu’à 12 établis maschi (F 1200). Les filtres sont également utilisés dans l’orfèvrerie et industries dérivées, dans les lycées professionnels ou centres d’apprentissage. La filtration s’effectue en 3 stades différents avec une efficacité croissante visualisée par un

manomètre différentiel de pression et par une cartouche filtrante régénérable. Dans ce cas, le manomètre sera considéré comme une option. Pour les version avec charbons actifs: ces derniers ne sont pas régénérables, il doivent être changés régulièrement.

Application

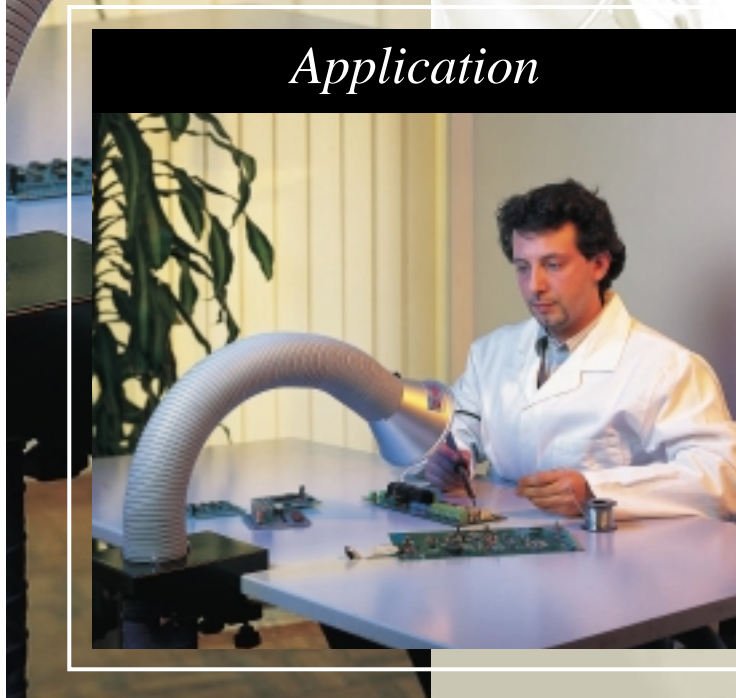

The “F series” of filter for aspiration and deodorization of the soft-soldering fumes was expressed and realized to consent a modularity in the filtering apparatus which increase the employment range very much. Studied for electronics factories for aspiration and filtering fumes from working place up to 12 (F 1200), wave soldering, soft-soldering, are also applied in pharmaceutic-chemistry fields, gold craft factories, professional schools. Filtering is performed through 3 different stages with increasing efficiency visually monitored by a differential manometer, or by a reusable filtering cartridge; in this model the differential manometer is supplied as optional.

F 800 F 1200

CENTRALIZED FILTERS

GERÄTE ZUR ZENTRALABSAUGUNG - FILTROS CENTRALIZADOS

Die Geräte der neuen Serie Typ "F" zur Löt Rauchfiltration bzw. Desodorierung finden sehr breite Anwendung dank der Modularität der verschiedenen, eingebauten Filter. Anwendungsgebiete sind die Elektronikindustrie zur Absaugung und Filtration des Löt Rauchs bis 12 (F 1200) Arbeitsplätzen und Wellenlötmaschinen, die Arzneimittelindustrie, Goldschmiedeindustrie, Berufsschulen. Die Filtration erfolgt entweder durch eine wiederverwendbare Filterpatrone oder drei verschiedene Filter mit steigendem Abscheidegrad, die dauernd durch Differenzdruckmesser überprüft werden; der Differenz-Druckwächter wird auf Wunsch gegen Mehrpreis geliefert.

La serie "F" de filtros para la aspiración y la desodorización de los humos de soldadura con estaño ha sido diseñada y realizada permitiendo una modularidad de los dispositivos de filtración que extiende enormemente su campo de empleo. Diseñados para la industria electrónica, para la aspiración y la filtración de humos de los puestos de trabajo hasta 12 (F 1200), soldadoras de onda, puestos de soldadura con estaño, también encuentran aplicación en el sector químico y farmacéutico, en la industria de la orfebrería, en las escuelas profesionales.

La filtración se produce a través de tres fases distintas de trabajo de eficiencia creciente, controladas visualmente mediante un presostato diferencial, o a través de un cartucho filtrante reutilizable; en esta versión, el presostato diferencial se entrega como elemento opcional. En la versión con carbones activos, éstos últimos no se pueden regenerar y se deben cambiar regularmente.





TECHNICAL FEATURES

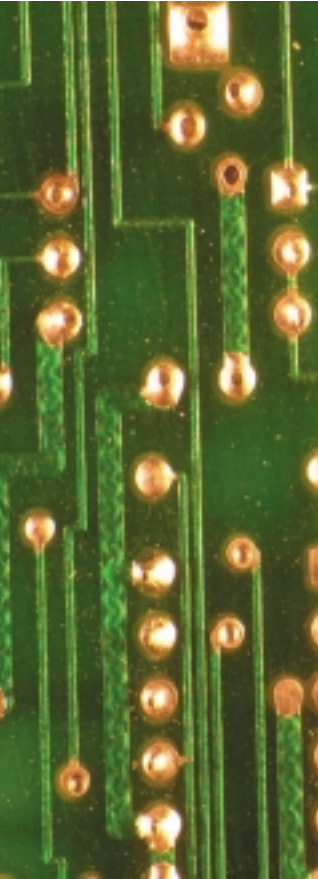

Caratteristiche tecniche
Caractéristiques techniques
Technische daten
Características técnicas

F200 F400

F200

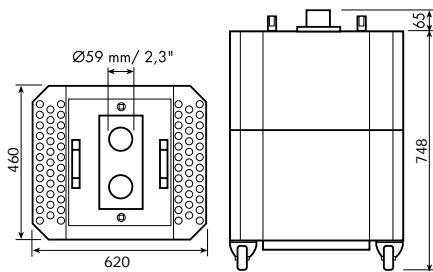

F400

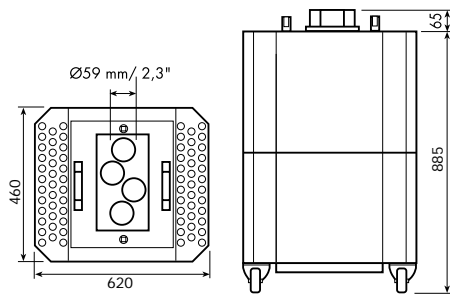

F200-F400

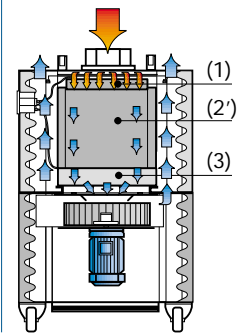

F200/C F400/C

F200/C

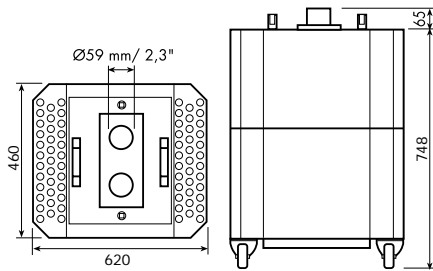

F400/C

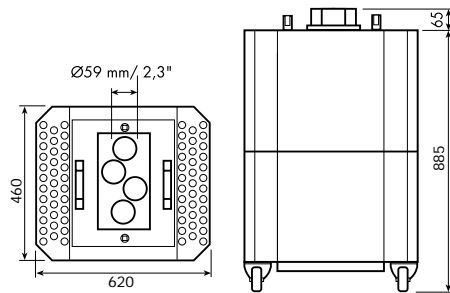

F200/C-F400/C

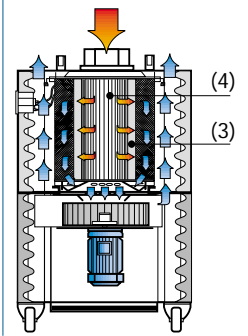

Dimensioni (mm)
 Dimensions (mm)
 Dimensions (mm)
 Abmessungen (mm)
 Medidas (mm)

F800 F1200 F800/S F1200/S

F800-F1200

D

	mm	inch
F 800	Ø150	Ø5,85
F 1200	Ø180	Ø7

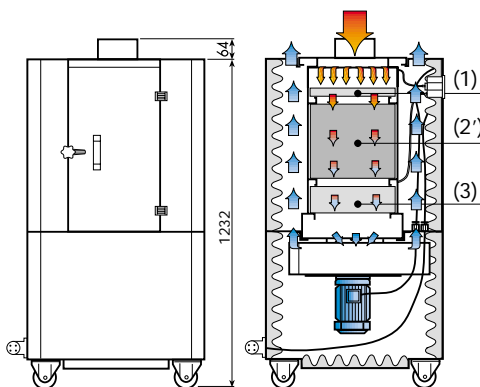
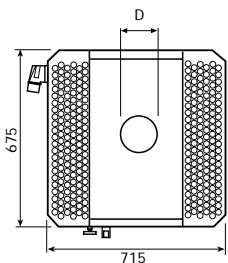

F800/S-F1200/S

D

	mm	inch
F 800/S	Ø150	Ø5,85
F 1200/S	Ø180	Ø7

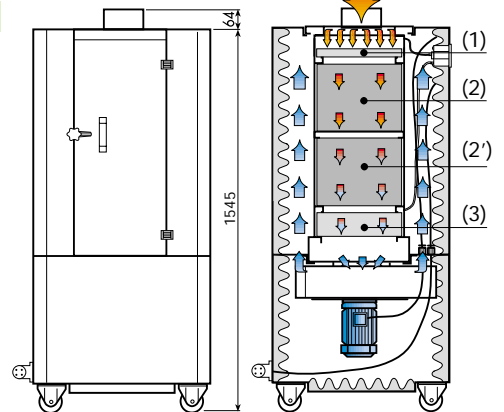
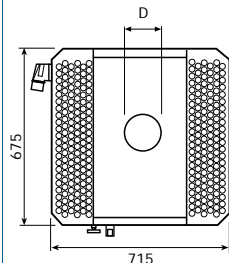

F200 F400 F800 F1200

	Filtri / Filtre / Filter / Filter / Filtros			
(1) Prefiltro Prefiltre Prefilter Vorfilter Prefiltro	(1) Prefiltro (1) Prefiltre (1) Prefilter (1) Vorfilter (1) Prefiltro	(2) Filtro intermedio (2) Filtre principal (2) Intermediate filter (2) Zwischenfilter (2) Filtro intermedio	(2') Filtro assoluto (2') Filtre absolu (2') Absolute filter (2') Absolutfilter (2') Filtro absoluto	(3) Carboni attivi (3) Charbons actifs (3) Activated carbons (3) Aktivkohle (3) Carbones activos
(2) Filtro intermedio Filtre principal Intermediate filter Zwischenfilter Filtro intermedio	F 200	87% EU 3	-	99,9 % EU 13 D.O.P. 4 Kg 1250 m2/g
(2') Filtro assoluto Filtre absolu Absolute filter Absolutfilter Filtro absoluto	F 400	87% EU 3	-	99,9 % EU 13 D.O.P. 4 Kg 1250 m2/g
(3) Carboni attivi Charbons actifs Activated carbons Aktivkohle Carbones activos	F 800	87% EU 3	-	99,9 % EU 13 D.O.P. 9 Kg 1250 m2/g
(4) Cartuccia Cartouche Cartridge Patrone Cartucho	F 800/S*	70% EU 2	65% EU 7 D.O.P	99,9 % EU 13 D.O.P. 9 Kg 1250 m2/g
	F 1200	87% EU 3	-	99,9 % EU 13 D.O.P. 9 Kg 1250 m2/g
	F 1200/S*	70% EU 2	65% EU 7 D.O.P.	99,9 % EU 13 D.O.P. 9 Kg 1250 m2/g

*Saldatrici ad onda e pozzetti stagno - Soudure a l'etain - Wave soldering machines and soldering equipments - Wellenlötmaschinen und Zinnschachten - Soldadoras de onda y pocillos de estaño

Cartuccia filtrante/Cartouche filtrante/Filtering cartridge/Filterpatrone/Cartucho filtrante

	(4) Cartuccia (4) Cartouche (4) Cartridge (4) Patrone (4) Cartucho	Media filtrante - Peso Média filtrante - Poids Filtering media - Weight Filtermedia - Gewicht Medio filtrante - Peso	Superficie filtrante Surface filtrante Filter surface Filterfläche Superficie filtrante m ² - sq.ft	Classificazione BIA Classification BIA BIA classification BIA-Kategorie Clasificación BIA	(3) Carboni attivi (3) Charbons actifs (3) Activated carbons (3) Aktivkohle (3) Carbones activos	Peso Poids Weight Gewicht Peso Kg
F 200/C	Non rigenerabile Pas regenerable Non regenerable nicht regenerierbar No regenerable	Poliestere Polyestere Polyester Polyestere	2,6 / 28	U, S, G & C		2,1 Kg - 1250 m ² /g
F 400/C						

Caratteristiche tecniche/Caractéristiques technique/Technical features/Tecnische Daten/Características técnicas

Tipo Modèle Type Typ Tipo	Potenza Puissance Power Motorstärke Potencia kW	Tensione Tension Voltage Spannung Tensión V	Portata Debit Capacity Luftmenge Caudal mc/h - c.f.m.	Sup. filtrante Surface filtrante Filter surface Filterfläche Sup. filtrante m ² - sq.ft	Efficienza Efficacité Efficiency Abscheidegrad Eficiencia %	Rumorosità Niveau sonore Average sound level Schallpegel Ruido dB(A)	Peso Poids Weight Gewicht Peso Kg
F 200	0,55	230/1/50	250 - 147	2 - 21,5	99,9	58	63
F 400	0,55	230/1/50	500 - 294	4,5 - 48,4	99,9	58	67
F 800	1,5	230/400/3/50	800 - 471	9 - 96,8	99,9	60	120
F 800/S							
F 1200	2,2	230/400/3/50	1200 - 706	9 - 96,8	99,9	60	160
F 1200/S							

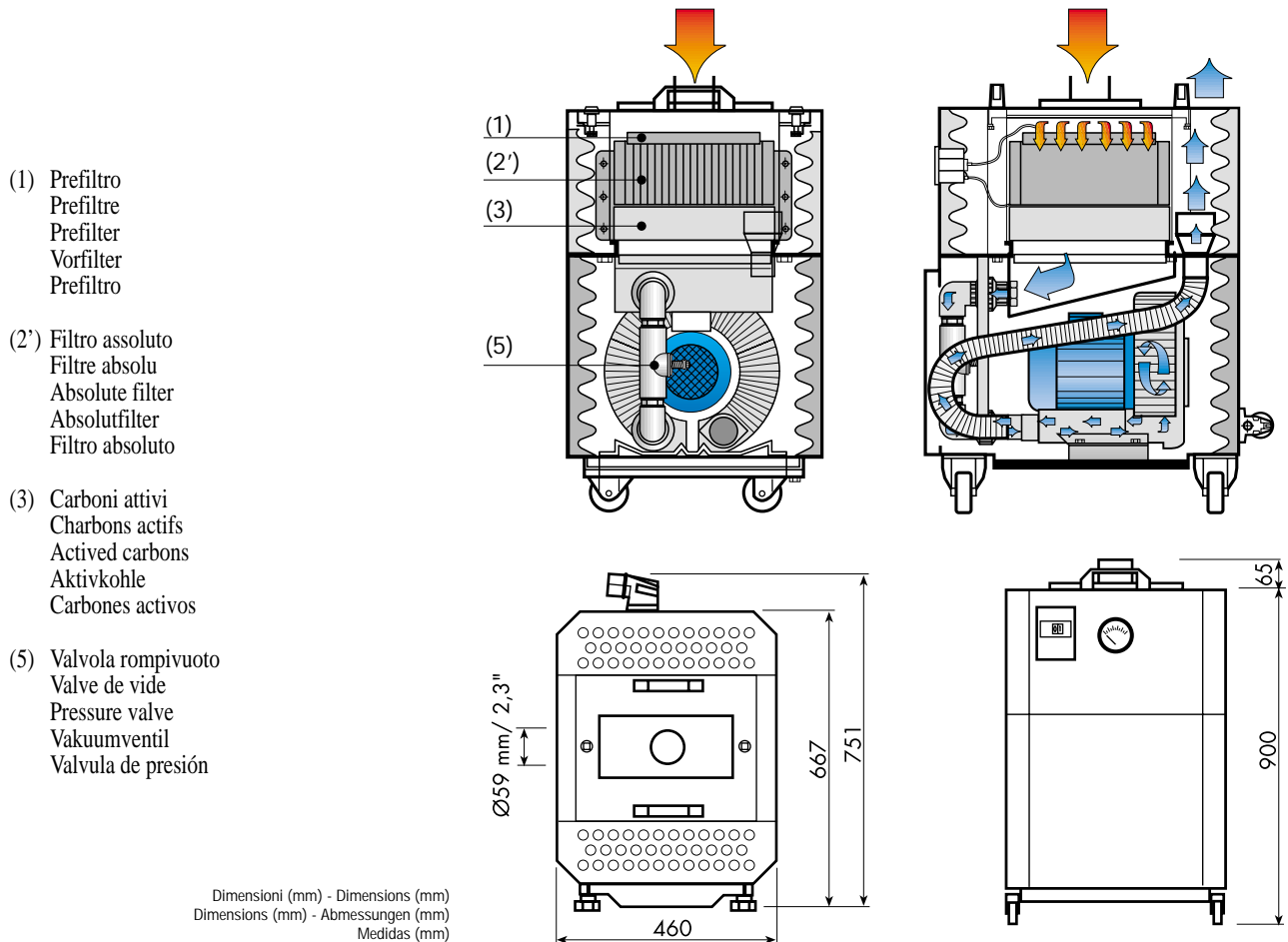

Caratteristiche tecniche/Caractéristiques technique/Technical features/Tecnische Daten/Características técnicas

Tipo Modèle Type Typ Tipo	Potenza Puissance Power Motorstärke Potencia	Giri Trs/min RPM Anzahl Vueltas	Tensione Tension Voltage Spannung Tensión	Portata Debit Capacity Luftmenge Caudal	Sup. filtrante Surface filtrante Filter surface Filterfläche Sup. filtrante	Efficienza Efficacité Efficiency Abscheidegrad Eficiencia	Depressione all'aspirazione Depression à l'aspiration Suction pression Unterdruck ansaugung Depresión en la aspiración
	kW		V	mc/h - c.f.m.	m ² - sq.ft	%	
F 260	2,2	2900	230/400	200 - 117,6	2 - 21,5	99,9	1250 mm H₂O

Tipo Modèle Type Typ Tipo	Rumorosità Niveau sonore Sound level Schallpegel Nivel sonoro	(1) Dimensione prefiltro (1) prefiltre (1) Prefilter dimension (1) Vorfilter (1) Dimensión prefiltro	(2') Dimensione filtro assoluto (2') filtre absolu (2') Absolute filter (2') Absolutfilter (2') Dimensión filtro absoluto	(3) Peso carboni attivi (3) Charbons actifs (3) Activated carbons (3) Aktivkohle (3) Peso carbones activos	Peso totale Poids total Total weight Gewicht Peso total
	dB(A)	mm	mm	Kg	Kg
F 260	73	260x260x22	305x305x150	4	75